

**MOUNTING GUIDE PROZESS REFRAKTOMETER  
SCHMIDT + HAENSCH GMBH 2006**

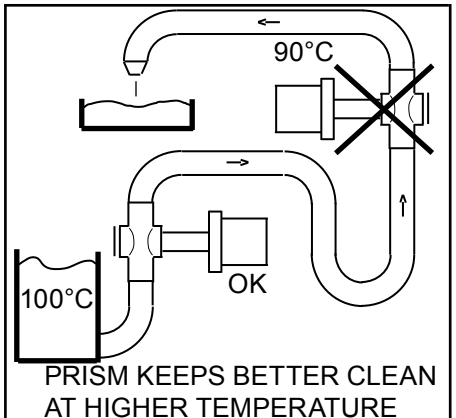
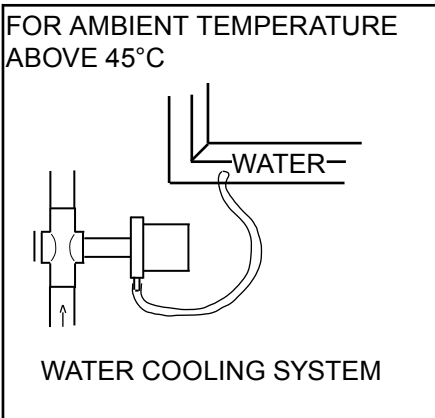
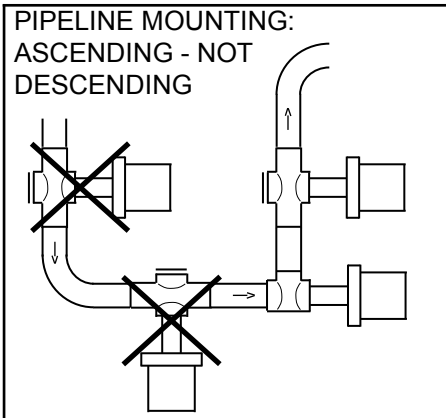
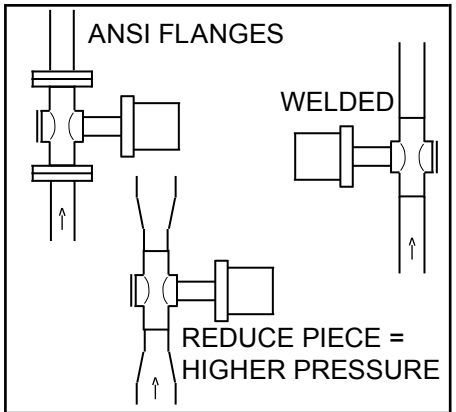
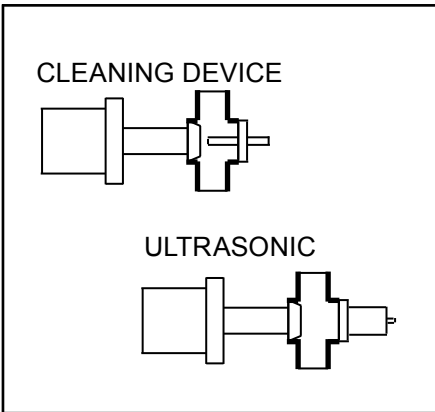
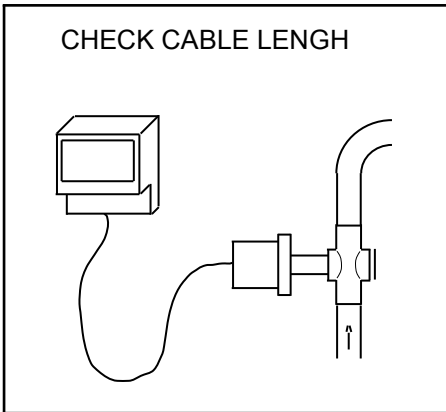
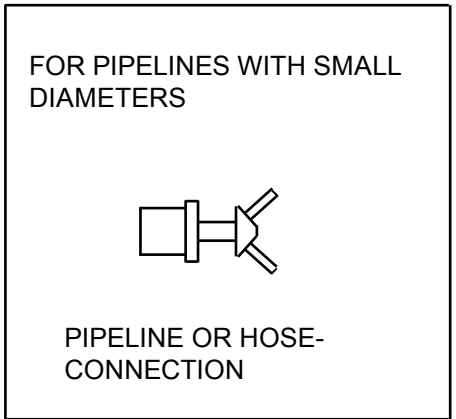
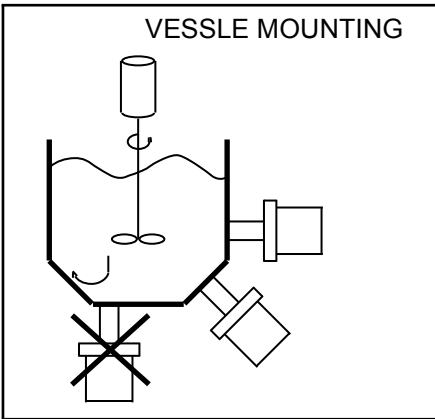
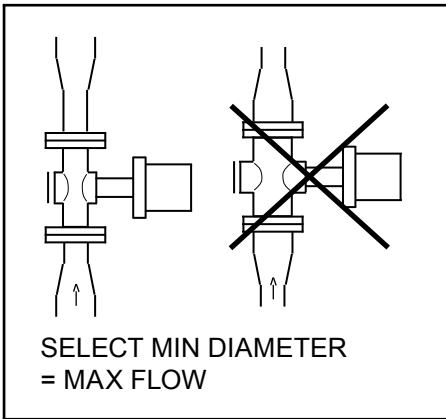
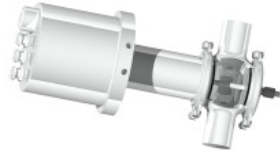

**INSTRUCTION MANUAL FOR S+H IPR BASIC / FULLRANGE / HIGH RANGE**